

Instruction Manual

Pearl Swivel Joint

A/AS/B/C/CS Series

This instruction manual applies to products with type designations that begin with A, AS, B, C, or CS. (This manual does not apply to movable pipelines or products with type designations that begin with AO, ASO, BO, CO, or CSO.)



This instruction manual describes important precautions for preventing accidents and how to handle the product. To ensure safe use, be sure to read this manual and fully understand its contents before using this product. Store this manual carefully so that it can be referred to at any time.

Pearl is a trade name of Showa Giken Industrial Co., Ltd.

Table of Contents

1. How to Read Nameplate (Nameplate Information)	P3
2. For Safety	P3
2-1) Symbols	P3
2-2) For safe use	P3
3. Product Overview	P4
3-1) Application	P4
3-2) Information indicated by model names	P4
3-3) Service conditions	P5
3-4) Precautions for use	P6
3-5) Product structures and materials	P7
3-6) Product dimensions	P8
3-7) Product masses	P8
3-8) Product torque	P9
4. Transport and Storage	P10
4-1) Transport	P10
4-2) Storage	P10
5. Installation	P10
6. Removal	P11
7. Operation	P11
7-1) Operation	P11
7-2) Operation shutdown	P11
8. Inspection and Maintenance	P12
8-1) Daily inspection	P12
8-2) Greasing	P12
8-3) Repair and replacement of consumables	P13
9. Troubleshooting	P14
10. Disposal	P15
11. Product Warranty	P15
A. Appendix – How to Repair or Replace Consumables	P17

1. How to Read Nameplate (Nameplate Information)

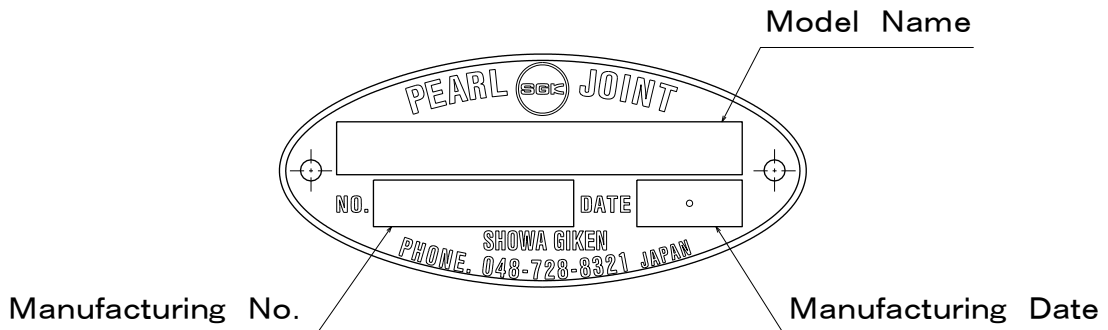

The nameplate attached to the product indicates the model name, manufacturing number, and manufacturing date.

2. For Safety

2-1) Symbols

The symbols used in this instruction manual are described below.



Indicates that failure to follow the warning message may cause bodily accidents that may result in serious or even fatal injury.



Indicates that failure to follow the caution message may cause personal injury or damage to peripheral equipment.



Indicates that failure to follow the instruction message may cause reduced product lifetime, product damage, or early leakage.



Indicates “prohibited actions”.

2-2) For safe use

1. Transport, storage, installation, piping, operation, or maintenance of this product should be carried out by an experienced expert.
2. Be sure to observe all warnings, cautions, and instructions described in each section.
3.  Never disassemble or modify this product because doing so is dangerous. We shall assume no responsibility for any malfunctions, accidents, or the results thereof involving a reassembled product after disassembly or a modified product. Also, a reassembled product after disassembly or a modified product shall not be covered by the product warranty even if the warranty period is still valid. This also applies to repairs done by yourself.
4. Confirm specifications (dimensions, materials, masses) indicated on individual product drawings before starting work. Contact our sales representative for requests for product drawings.
5. Always use the latest instruction manual. You can download the latest version from our website.

3. Product Overview

3-1) Application

A swivel joint is used when it is necessary to rotate a pipe for transporting fluid or move it up/down, left/right, or forward/backward.

3-2) Information indicated by model names

Information indicated by each series model names is described below.

The product list is shown in our catalog or on our website.

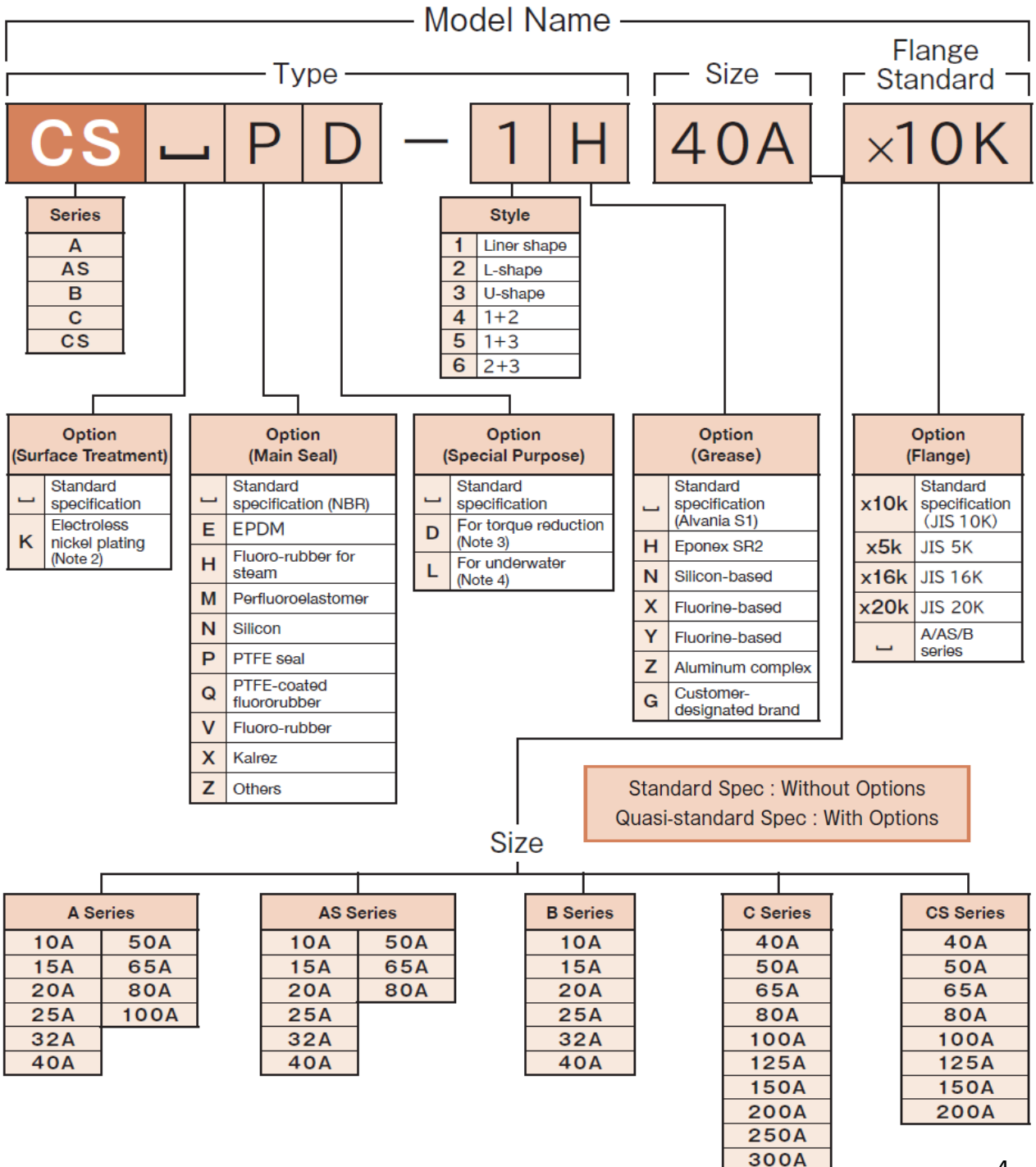

- Note. 1) “ ” indicates a space. A model name is indicated without spaces.
 2) Electroless nickel plating is applied to the shaft and body when option (surface treatment) code K is selected. This is applicable to the A series (65A to 100A) and C series (all sizes).
 3) The dust seal is replaced with felt when option (special purpose) code D is selected.
 4) The grease nipple is replaced by a plug with liquid packing applied to the thread when option (special purpose) code L is selected.
 5) Flanges of the C and CS series are JIS10K SOP FF as standard.

If you have any questions, contact our sales representative.

3-3) Service conditions

Service Conditions of Each Series

Series	Connection	Material (main parts)	Main Seal	Style	Size	Max.	
						Pressure (MPa)	Temperature (°C)
A	Taper Thread (Rc)	Ductile Cast Iron Carbon Steel	O-ring NBR	1~6	10A~100A	4.1	100
AS	Taper Thread (Rc)	Stainless Steel	O-ring NBR	1~6	10A~40A	4.1	100
				1~3	50A	4.1	
					65A, 80A	2.1	
B	Taper Thread (Rc)	Carbon Steel	O-ring NBR	1~3	10A~15A	13.7	100
					20A~32A	9.0	
					40A	6.0	
C	Flange	Carbon Steel	O-ring NBR	1~6	40A~300A	2.1	100
CS	Flange	Stainless Steel	O-ring NBR	1~6	40A~200A	2.1	100

- Note. 1) The main seal material for the standard specification of each series is NBR, and the maximum service temperature is 100°C.
 2) The tables above on the next page indicate guidelines for the service temperature ranges of the main seal and grease. They are not the joint service temperature range.
 3) 20A to 40A of B series can be used for up to 13.7 MPa under the following conditions.
 ① When the swivel operation is not performed while fluid is flowing at a pressure of the maximum value in the table above to 13.7 MPa.
 ② When the swivel operation is performed while fluid is flowing at a pressure of the maximum value in the table above to 13.7 MPa, but the frequency of swivel operation is below our standard value.

Contact our sales representative for more information.

Main seal material and service temperature range (guideline)

Option Code (Main Seal)	Material	Temperature Range (°C)
┌	NBR (Standard)	-20~100
E	EPDM	-40~120
H	Fluoro-rubber for steam	~160
M	Perfluoroelastomer	~200
N	Silicon rubber	-50~150
P	PTFE seal	~180
Q	PTFE-coated fluoro-rubber	~160
V	Fluoro-rubber	-10~160
X	Kalrez	~250
Z	Other	-

Grease type and service temperature range (guideline)

Option Code (Grease)	Brand	Material	Application	Temperature Range (°C)
┌	Alvania S1 (Standard)	Lithium-based	General purpose	-35~120
H	Eponex SR2	Lithium complex	General purpose	-20~200
N	-	Silicon-based	General purpose	-40~200
X	-	Fluorine-based	High-temperature	-30~260
Y	-		Oxygen	-15~150
Z	-	Aluminum complex	Food-processing machinery	-20~160
G	Customer's designation	-	-	-

Kalrez® is a registered trademark of E.I. du Pont de Nemours and Company.

Alvania S1 is a product of Shell Lubricants Japan K.K..

Eponex SR2 is a product of Idemitsu Kosan Co., Ltd..



3-4) Precautions for use

Use this product by following the warnings and instructions described below.

 WARNING

1. If flammable fluids leak and ignite, bodily accidents including serious or even fatal injury, or accidents that damage peripheral equipment may occur due to explosion or fire. Depending on the type of fluid, this product may subject to restrictions due to national laws or local regulations.
2.  This product cannot be used for food-processing machinery. Doing so may lead to adverse health effects.

 Instruction

1. Perform operation within the service conditions.
2.  The standard specification main seal (NBR) cannot be used for phosphoric ester-based hydraulic oil, chlorinated hydrocarbon-based hydraulic oil, organic solvents, or acids.
3.  **If a PTFE seal is used as a main seal, the product cannot be used under negative pressure.** If used under such pressure, the seal may be deformed, causing fluid leakage.
4.  The product cannot be used for fluid that causes corrosion on it.
5. As an elastic seal is used, use of the product in consecutive rotation condition is not appropriate. The product lifetime becomes shortened.
6. The bearing section is high precision machined and there is no clearance (play). Shaft movement is restricted in the swivel direction. When introducing a hose for connecting the product or a movable pipeline for using multiple products, carefully consider the motion of the hose and the movable pipeline before selecting a style.

3-5) Product structures and materials

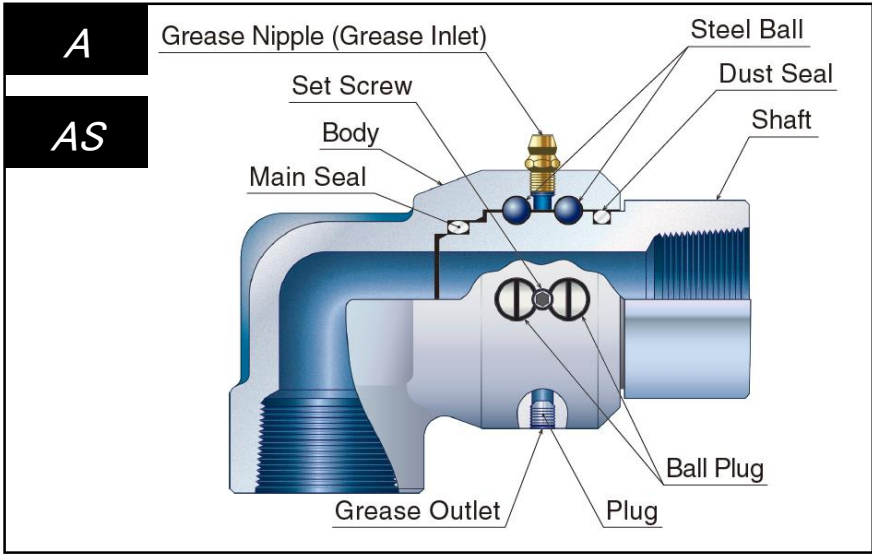

Materials of Main Components
(Standard Specification)

	Part Name	Material
A	Shaft	Ductile Cast Iron
	Body	Carbon Steel
	Main Seal	NBR

Shafts and bodies of sizes 10A to 50A are finished with electroless nickel plating. Heat-resistant paint is applied to external parts of sizes 65A to 100A.

Materials of Main Components
(Standard Specification)

	Part Name	Material
AS	Shaft	Stainless Steel
	Body	
	Main Seal	NBR

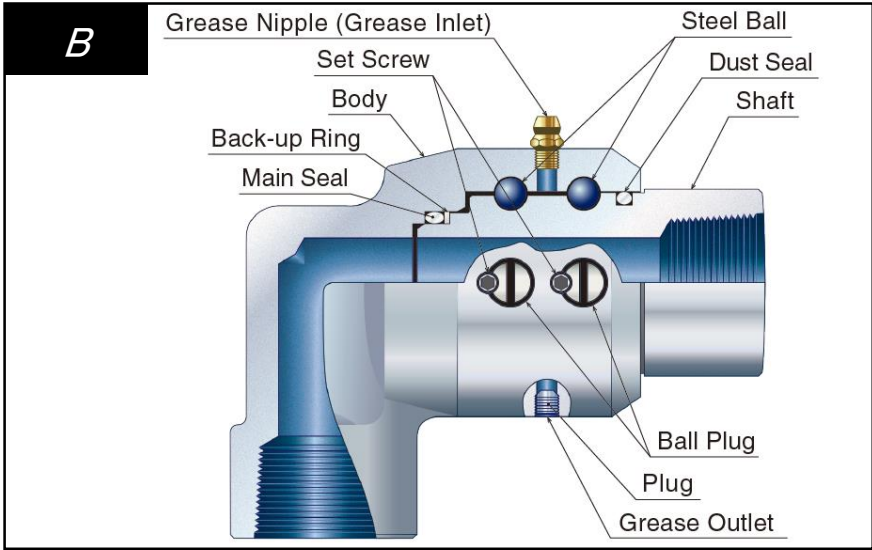

Materials of Main Components
(Standard Specification)

	Part Name	Material
B	Shaft	Carbon Steel
	Body	
	Main Seal	NBR

The shaft and body are finished with electroless nickel plating.

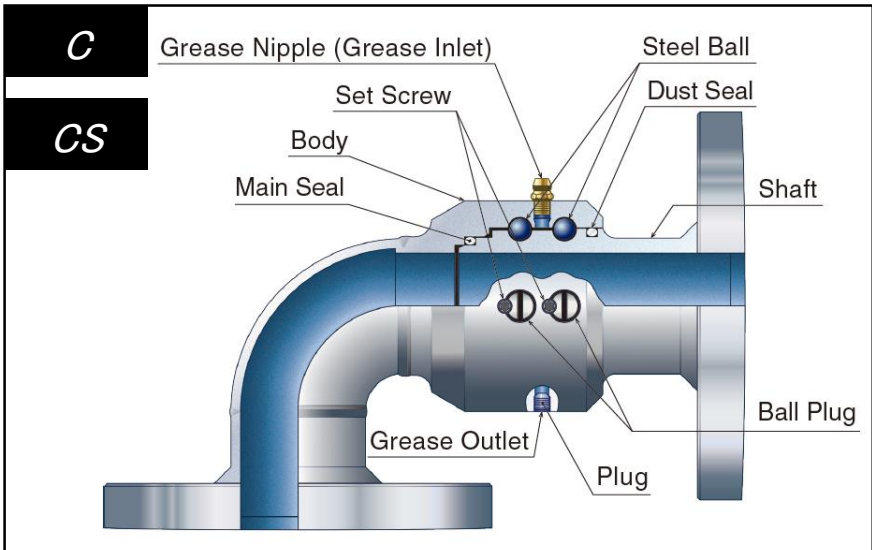

Materials of Main Components
(Standard Specification)

	Part Name	Material
C	Shaft	Carbon Steel
	Body	
	Main Seal	NBR

Heat-resistant paint is applied to external parts.

Materials of Main Components
(Standard Specification)

	Part Name	Material
CS	Shaft	Stainless Steel
	Body	
	Main Seal	NBR

Note) Component materials are indicated on product drawings.
Contact our sales representative for requests for product drawings.

3-6) Product dimensions

Product dimensions are shown on product drawings, in our catalog, or on our website.

3-7) Product masses

Masses of A Series (kg)

Size	Style					
	1	2	3	4	5	6
10A	0.6	0.65	0.75	1.0	1.1	1.2
15A	0.55	0.6	0.7	0.9	1.0	1.1
20A	1.3	1.4	1.6	2.2	2.3	2.5
25A	1.2	1.3	1.5	2.1	2.2	2.4
32A	2.3	2.8	3.5	3.8	4.5	5.2
40A	2.2	2.7	3.3	3.8	4.4	5.0
50A	4.5	5.2	6.3	8.0	9.2	10.2
65A	9.8	11.8	14.3	17.6	20.2	22.6
80A	9.0	11.0	13.5	16.6	19.2	21.8
100A	14.5	17.6	20.5	26.5	29.5	32.3

Masses of AS Series (kg)

Size	Style					
	1	2	3	4	5	6
10A	0.6	0.7	0.9	1.3	1.4	1.6
15A	0.55	0.65	0.85	1.3	1.4	1.6
20A	1.3	1.55	1.9	3.1	3.1	3.4
25A	1.2	1.5	1.75	3.0	3.0	3.3
32A	2.0	2.8	3.8	4.2	4.9	5.6
40A	2.1	2.8	3.6	4.7	5.2	5.8
50A	4.0	5.5	7.3	-	-	-
65A	5.5	6.2	6.9	-	-	-
80A	7.0	7.6	8.6	-	-	-

Masses of B Series (kg)

Size	Style		
	1	2	3
10A	0.8	1.0	1.2
15A	0.7	0.9	1.1
20A	1.9	2.2	2.8
25A	1.8	2.1	2.7
32A	2.2	2.8	3.4
40A	2.3	3.4	4.4

Masses of C Series
(Standard Specification) (kg)

Size	Style					
	1	2	3	4	5	6
40A	5.3	5.5	5.7	7.2	7.4	7.6
50A	7.2	7.6	8.0	10.6	11.0	11.3
65A	10.4	11.0	11.5	15.3	15.8	16.4
80A	11.3	12.1	13.0	17.0	17.9	18.7
100A	15.6	17.0	18.5	24.6	26.0	27.4
125A	25	27	29	39.5	42	44
150A	39	42.5	46	65	68.5	72
200A	59	67	74	104	112	119
250A	87	101	114	152	168	182
300A	120	140	160	220	240	260

Masses of CS Series
(Standard Specification) (kg)

Size	Style					
	1	2	3	4	5	6
40A	5.3	5.4	5.6	7.2	7.4	7.6
50A	7.2	7.5	7.9	10.6	11.0	11.3
65A	10.4	10.9	9.0	15.3	15.8	16.4
80A	11.3	12.0	12.9	17.0	17.9	18.7
100A	15.6	16.9	18.5	24.6	26.0	27.4
125A	25	27.4	30	39.5	42	44
150A	39	42.5	46	65	68.5	72
200A	59	68	76.5	104	112	119

Note) Standard specification flanges of the C and CS series are JIS10K.

3-8) Product torque

- * Dynamic torque varies depending on product storage conditions, storage period, or fluid types.
- * Starting torque is larger than dynamic torque. Although starting torque is even larger when wringing occurs, it does not indicate any fault.
- * Data are typical values measured based on in-house test standards. They are not guaranteed values.

A/AS Series Dynamic torque(10A~100A)

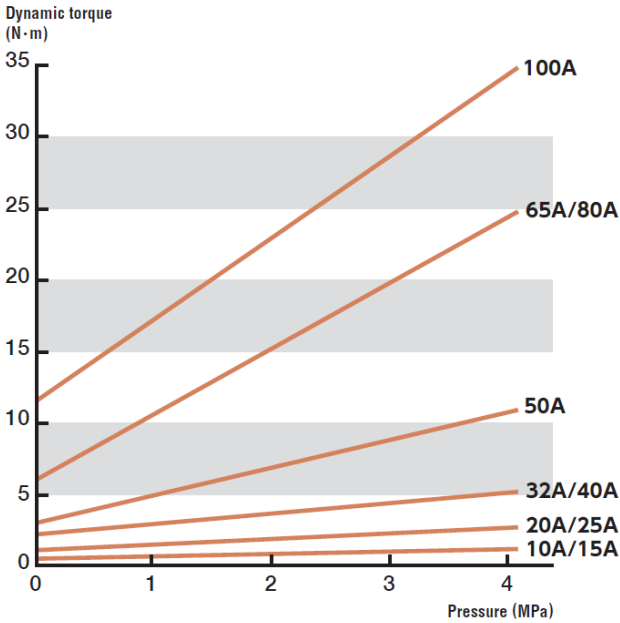

B Series Dynamic torque(10A~40A)

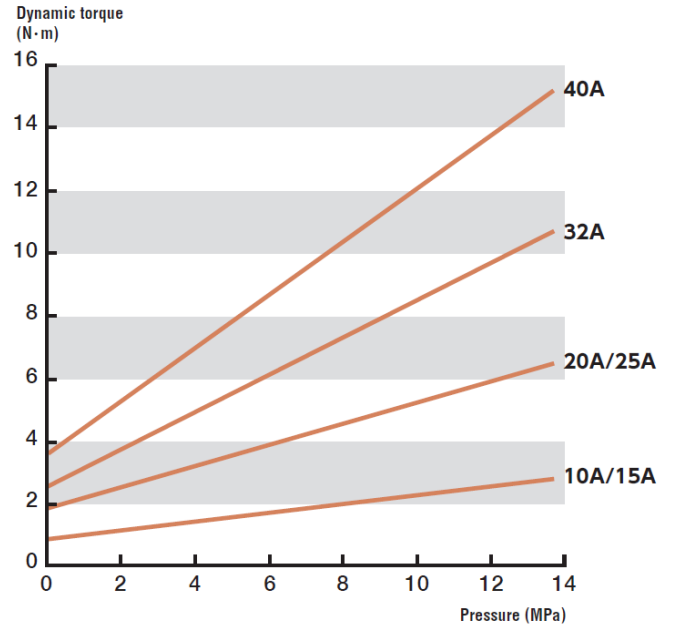

C/CS Series Dynamic torque(40A~80A)

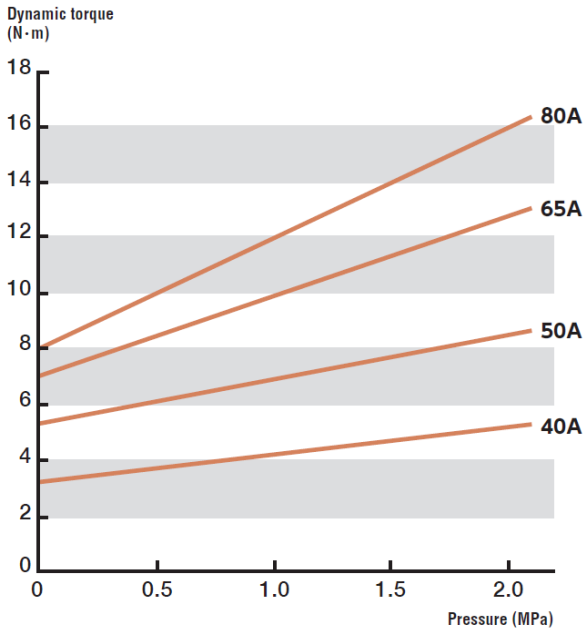

C/CS Series Dynamic torque(100A~300A)

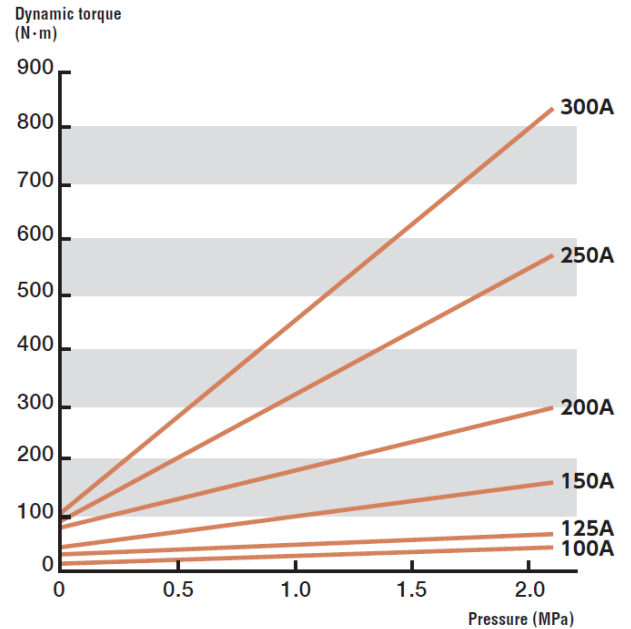

4. Transport and Storage

4-1) Transport

Transport this product by following the cautions and instructions described below.



CAUTION

To transport a product that weighs over 25 kg, use appropriate lifting equipment to prevent injuries.



Instruction

Do not subject the product to undue impact while it is being transported. Falling down or impact causes product damage (grease nipple etc.) or early leakage. If the product fell down or was damaged, contact us for maintenance.

4-2) Storage

An improper storage method causes product damage or early leakage.

Store this product by following the instructions described below.



Instruction

1. Wrap the product before storing it to prevent the entry of foreign objects.
2. Store this product in a dry environment at 10°C to 40°C.
3. The storage period should be within two years. If the storage period exceeds two years, contact us for maintenance.
4. If the product is stored after use, clean and then store it under the above conditions.

5. Installation

Product adjustment is not required before installation.

Install the product by following the cautions and instructions described below.



CAUTION

In order to prevent injuries, take the product weight into consideration before installing the product. Use equipment such as a crane as necessary. This work should be performed by two or more persons.



Instruction

1. **Thoroughly flush flow passages to remove foreign objects** before product installation. If the fluid contains foreign objects, install a strainer at the flow passages. Foreign objects cause early leakage.
2.  **Avoid pipe laying where excessive moment load is applied to the product.** Failure to do so can cause early leakage.
3. When tightening screws or nuts, properly torque-tighten them according to the screw type or size.
4. To prevent uneven tightening, evenly tighten flange screws in a cross pattern.
5. Perform retightening after the start of use.

6. Removal

Perform removal by following the warnings and cautions described below.



WARNING

In order to prevent bodily accidents due to residual fluid in the product or pipes, remove the product after fluid has been completely drained from the product or pipes and temperature has dropped to room temperature.



CAUTION

In order to prevent injuries, take the product weight into consideration before removing the product. Use equipment such as a crane as necessary. This work should be performed by two or more persons.

7. Operation

7-1) Operation

Perform operation by following the warnings and cautions described below.



WARNING

Immediately stop operation if fluid leakage is detected during operation. If operation is continued with fluid leakage not being repaired, serious accidents including bodily accidents may result.



CAUTION



During rotation or high-temperature/pressure fluid flow, keep well away from the product to prevent injuries or burns. Do not directly touch rotating or hot parts during operation.

7-2) Operation shutdown

Follow the following instructions during operation shutdown.



Instruction



Do not put your hand on or ride on the product during equipment maintenance. Doing so may cause product damage or fluid leakage after operation restart.

8. Inspection and Maintenance

8-1) Daily inspection



Perform inspection according to the following instructions.

 Instruction	<ol style="list-style-type: none"> 1. Visually check connections and the product for fluid leakage. If leakage is detected, repair the product or replace it with a new one. 2. When replacing, use the same type of product with the same size.
---	--

8-2) Greasing

The bearing section and main seal require periodic greasing (refilling).

Carry out greasing according to the following instructions.

 Instruction	<ol style="list-style-type: none"> 1. Remove the grease outlet plug and fill the grease through the grease nipple (grease inlet). Continue to fill until new grease comes out from the grease outlet. 2. <u>If the grease is filled without removing the plug, parts inside the product may be damaged by the grease pressure, causing fluid leakage.</u> 3.  Use the same grease as the one filled in the product before shipment. Do not use grease mixed with other ones. Doing so may reduce the lubricating effect. 4. Carry out greasing with reference to the frequency and amount (guideline) shown in the following table. Failure to carry out greasing can reduce the lubricating performance of the grease, causing the reduction in the ball bearing lifetime.
---	---

< Grease filled in the product before shipment >

1. Alvania S1 (Shell Lubricants Japan K.K.) is filled in standard specification products.
2. Grease different from the standard specification is filled if a model name includes an option (grease) code. Check the grease brand before greasing.

Greasing Frequency (Guideline)

Fluid Temperature (°C)	Greasing Frequency
0~60	Yearly
60~100	Every six months

A Series
Grease Amount (Guideline) (cm³)

Size	First Time	Refill
10A	1.5	0.8~0.9
15A	1.5	0.8~0.9
20A	2	1.0~1.6
25A	2	1.0~1.6
32A	4	2.0~2.4
40A	4	2.0~2.4
50A	8	4.0~4.8
65A	23	12~14
80A	23	12~14
100A	29	15~17

AS Series
Grease Amount (Guideline) (cm³)

Size	First Time	Refill
10A	1.5	0.8~0.9
15A	1.5	0.8~0.9
20A	2	1.0~1.6
25A	2	1.0~1.6
32A	4	2.0~2.4
40A	4	2.0~2.4
50A	10	5.0~6.0
65A	13	6.5~7.8
80A	14	7.0~8.4

B Series
Grease Amount (Guideline) (cm³)

Size	First Time	Refill
10A	2	1.0~1.2
15A	2	1.0~1.2
20A	4	2.0~2.4
25A	4	2.0~2.4
32A	4	2.0~2.4
40A	5	2.5~3.0

C Series
Grease Amount (Guideline) (cm³)

Size	First Time	Refill
40A	5	2.5~3.0
50A	10	5.0~6.0
65A	13	6.5~7.8
80A	14	7.0~8.4
100A	20	10~12
125A	23	12~14
150A	67	34~40
200A	147	74~88
250A	165	83~99
300A	260	130~156

CS Series
Grease Amount (Guideline) (cm³)

Size	First Time	Refill
40A	5	2.5~3.0
50A	10	5.0~6.0
65A	13	6.5~7.8
80A	14	7.0~8.4
100A	20	10~12
125A	23	12~14
150A	67	34~40
200A	147	74~88

8-3) Repair and replacement of consumables

The bearing section and main seal become worn over the course of operation time. Moreover, the main seal deteriorates and then such malfunctions as fluid leakage may occur. However, the product can be reused by repairing or replacing worn or deteriorated parts.

Contact us for repair or parts replacement. We carry it out according to our repair program. Depending on the products, expenses for purchasing new products may be lower than repair expenses. Consult with us when requesting repair or replacement.

< When carrying out repair or replacement of consumables by yourself >

- Repair or replacement should be carried out by an experienced expert.
- Perform work according to “A. Appendix – How to Repair or Replace Consumables”.
- Use our genuine parts as replacement parts.
Contact our sales representative to request genuine parts.
- Properly dispose of waste resulting from work according to national laws or local government regulations or ordinances.

(Attention)

If you carry out repair or replacement, we shall assume no responsibility for any product malfunctions, equipment malfunctions or accidents resulting from such product or the results thereof. Also, the product shall not be covered by the product warranty even if the warranty period is still valid.

9. Troubleshooting

This section describes the possible causes of and countermeasures against malfunctions. If a problem persists, contact our sales representative for assistance.

Malfunctions	Causes	Countermeasures
Fluid is leaking.	The main seal is damaged. The main seal lifetime has been reached.	Contact us for repair. Alternatively, replace with a new one.
	The fluid contains foreign objects.	Clean the inside of the product and pipes. Install a strainer.
	Excessive moment acts on pipes, etc.	Review the pipe laying method.
	An improper main seal material was selected.	Consult with us.
	A product that includes a PTFE seal as a main seal is used under negative pressure, or a high moment acts on the product. (* 1)	Consult with us.
The shaft does not rotate. (Starting torque is high.)	The ball race is deformed, and the shaft and body come in contact with each other.	Replace with a new one.
	The seal causes wringing.	Rotate the shaft a few turns to check that it rotates smoothly before use.
	Sticking of fluid (that has ability to solidify).	After using the product, clean its inside to remove foreign objects.
Lifetime is shortened.	The product is used in consecutive rotation condition or at high-rotation speed.	Consult with us. (The selected product may be inappropriate.)
Oil is leaking from a ball plug.	Oil released from grease seeps from the gap between the ball plug and body.	No fault is indicated. (* 2)

(* 1) A PTFE seal is a spring-loaded seal consisting of a Teflon cover and a metal spring. Teflon is easily deformed in a plastic manner. Therefore, using a Teflon seal in a vacuum condition or applying a high moment load to it may deform the seal, possibly resulting in fluid leakage.

(* 2) The ball plug tightened into the body has a parallel thread. As it does not have sealing ability, oil released from grease in the bearing section may seep from the gap between the ball plug and body.

10. Disposal

When disposing of packaging materials or products, properly dispose of them according to national laws or local government regulations or ordinances.

11. Product Warranty

If a malfunction occurs during the warranty period, contact us or the distributor and send the product to us. Be sure to carefully pack the product for protection before sending it. After receiving the product, we will confirm the malfunction. If the malfunction was clearly caused by the materials of product components or the manufacturing method, we will repair the product in question or replace it with a new one free of charge.

Product Warranty Provision

1. Warranty period

<New products>

One (1) year and six (6) months after shipment (from the manufacturing date) or one (1) year after installation, whichever comes first.

<Repaired products>

Six (6) months after shipment (from the manufacturing date).

2. We charge a fee for repairs in any of the following cases.

- ① Failure after the warranty period has expired
- ② Failure caused by use of the product deviating from the service conditions
- ③ Failure caused by misuse
(improper storage, installation, pipe laying, operation or maintenance, etc.)
- ④ Failure caused by fluid contaminants or foreign objects in the fluid
- ⑤ Failure caused by relocation, transport, or falling of the product after delivery
- ⑥ Failure caused by disassembly, repair, or modification done by personnel other than our service personnel
- ⑦ Failure of the product attributed to using materials or according to standards specified by the customer
- ⑧ Failure of the product attributed to using materials provided by the customer
- ⑨ Failure caused due to unavoidable acts of nature such as fires or other natural disasters

3. Scope of responsibility

Our responsibility shall be limited to repairs, replacements, or transport expenses covered by this product warranty provision. Expenses or damages caused by said failures above shall not be covered.

4. Applicable regions

This product warranty provision shall be applicable to products installed in Japan.

Contact our sales representative if you install and use our products outside Japan.

5. Another agreement

If another product warranty agreement is made separately with us and clearly states that said agreement shall have priority over this product warranty provision, this provision shall not be applicable.

6. This product warranty provision shall not restrict the customer's legal rights.

PEARL  **JOINT**
株式会社 昭和技研工業
SHOWA GIKEN INDUSTRIAL CO., LTD.

URL <https://www.sgk-p.co.jp>



Export Department Phone : +81-3-3598-1400 Fax. : +81-3-3598-2700
E-mail : sgk-tk@sgk-p.co.jp
Headquarters 7-24, Nishi-Kobari, Ina-Machi, Saitama, 362-0811 Japan
Phone : +81-48-728-9460 Fax. : +81-48-728-9461
Tokyo Sales Office 2-64-11, Akabane, Kita-ku, Tokyo, 115-0045 Japan
Phone : +81-3-3598-1400 Fax. : +81-3-3598-2700
Osaka Sales Office 2-9-7, Toyosaki, Kita-ku, Osaka, 531-0072 Japan
Phone : +81-6-6371-8341 Fax. +81-6-6371-6283
Nagoya Sales Office 41-1, Higashi-Ozone-cho, Higashi-ku, Nagoya, 461-0022 Japan
Phone : +81-52-938-8825 Fax. : +81-52-938-6423

A. Appendix – How to Repair or Replace Consumables

As each series has the same structure, the same workflow is applied.

- * Some products have two set screws ⑥.
- * A set screw is used as a plug ⑧ for products up to 100A, and a hex. socket head tapered pipe plug is used for products that are 125A or larger.
- * A back-up ring is used for main seal ③ of the B series only.

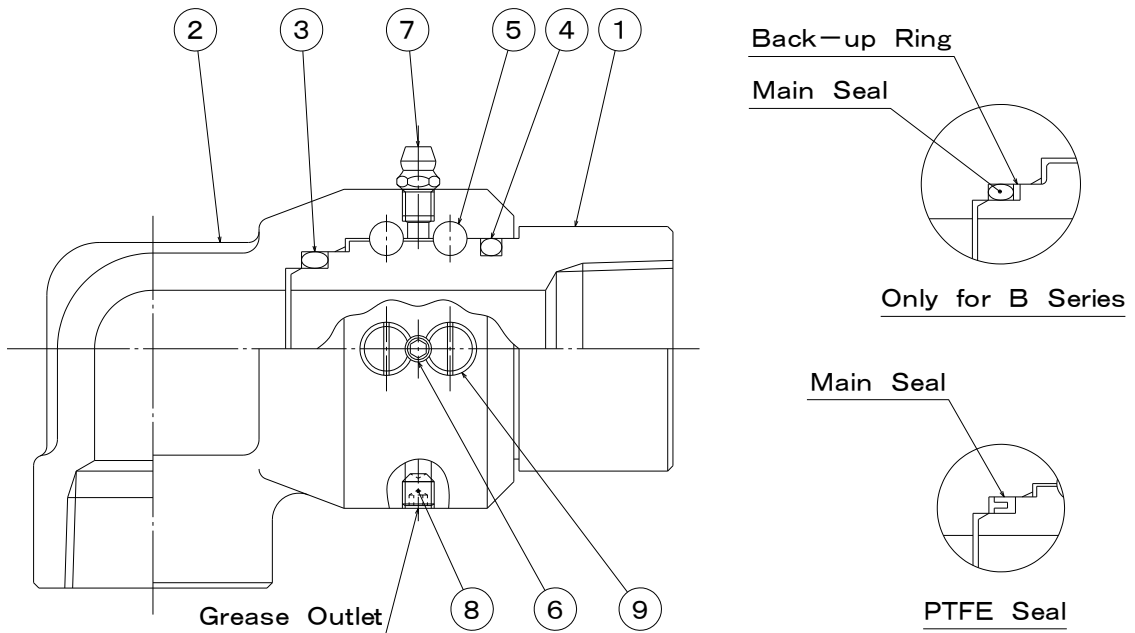

- ①Shaft ②Body ③Main Seal ④Dust Seal ⑤Steel Ball
⑥Set Screw ⑦Grease Nipple ⑧Plug ⑨Ball Plug

< Disassembly >

Carefully disassemble the product so that each part is not damaged.

- 1) Remove grease nipple ⑦ and plug ⑧.
- 2) Remove set screw ⑥.
- 3) Remove ball plugs ⑨.

* When assembling, it is necessary to reinstall both ball plugs in their original positions.

Place a marking so that users cannot make errors.

- 4) Face the ball plug side downward, and then remove all steel balls ⑤ while alternately turning shaft ① in clockwise/counterclockwise.
- 5) Pull out shaft ① from body ②.
- 6) Remove main seal ③ and dust seal ④.

< Inspection >

Clean each part and check for damage. In particular, check wear and damage conditions of the ball race section between shaft ① and body ②, and the sliding surfaces against main seal ③ and dust seal ④. Depending on the degree of damage, some parts may not be reused.

< Parts replacement >

- 1) Replace main seal ③, back-up ring (B series only), and dust seal ④ with new ones regardless of their conditions.
- 2) If reuse of parts is impossible, replace them with our new genuine parts.
Contact our sales representative to request genuine parts.

< Assembly >

Carefully assemble the product so that each part is not damaged.

- 1) Apply grease to the surfaces of shaft ① and body ② with which main seal ③ and dust seal ④ come in contact.
- 2) Install main seal ③ to body ②.
 - * For the B series, also install the back-up ring.
 - * Be careful of the installation direction of the PTFE seal if it is used.
- 3) Install dust seal ④ to shaft ①.
- 4) Insert shaft ① into body ②.
- 5) Push shaft ① against body ②, and then put in steel balls ⑤ while alternately turning shaft ① in clockwise/counterclockwise.
- 6) Attach ball plugs ⑨ to their original positions.
- 7) Install set screw ⑥.
- 8) Turn shaft ① a few turns clockwise/counterclockwise to make sure there is no fault.
- 9) Install grease nipple ⑦ and fill the grease through it. Continue to fill until new grease comes out from the grease outlet.
- 10) After greasing, attach plug ⑧.